

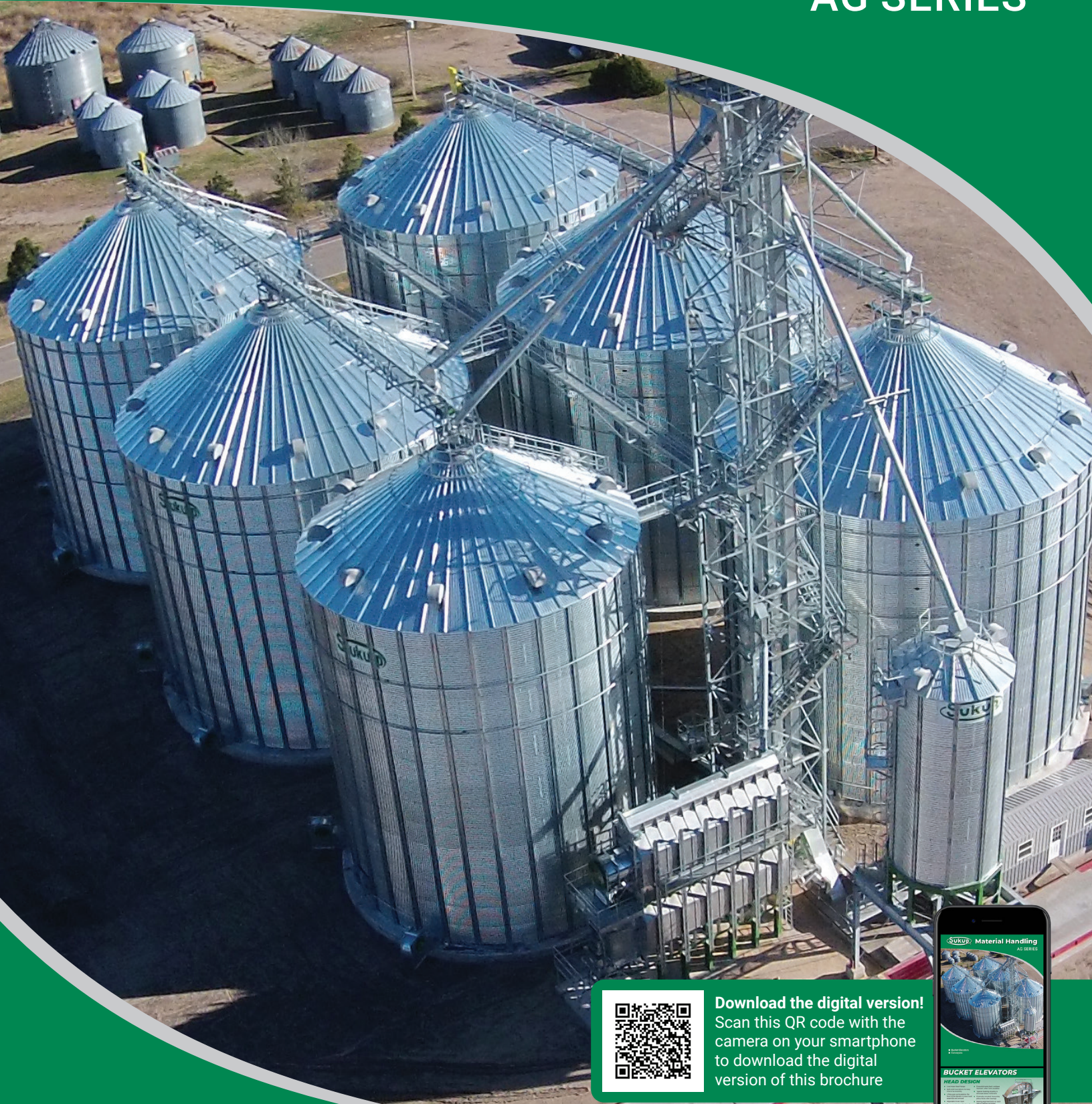

Material Handling

AG SERIES



Download the digital version!
Scan this QR code with the camera on your smartphone to download the digital version of this brochure



- Bucket Elevators
- Conveyors

BUCKET ELEVATORS

HEAD DESIGN

- Low-impact head design
- Split-style hood allows for easy interior accessibility
- Lifting eyes are located on the hood of the elevator to ease hood assembly and removal
- Adjustable throat wiper
- Bearing jack bolts with shims for easy leveling of pulley
- Interior lip to keep moisture out and dust in
- Expanded metal-back urethane standard on 36" and larger. Other liners available
- Tapered bushing at pulley to eliminate lateral movement
- Externally mounted, heavy-duty pillow block roller bearings
- Bearing alignment bolts on each side of bearing for proper pulley positioning



INTERMEDIATE

- Our patented squaring plates and alignment pins are placed at the top and bottom of every section to align trunking and eliminate the nightmare of twisted trunk sections, making assembly easier.
- Built square and parallel for no-hassle construction
- Sliding view port can be placed in three positions on inspection section
- Ten foot inspection section facilitates belt and splice installation
- Heavy welded frame with large removable panels on inspection section
- Heavy-gauge, huck-bolted units
- Dust-tight and weather-tight protection



“The squaring plates made the trunking easy to assemble. Having one end held together with squaring plates made it easy to hold the other end while trying to put an entire section of trunking together. The ladder and rest platforms also assembled easily.”

-Bryan Blakstad
Lodermeier's Inc. - Goodhue, MN

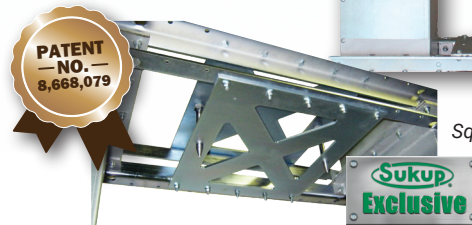

Squaring Plates & Alignment Pins

BOOT

- Large, easy access doors with a unique spring latch
- Large, easy-access clean-out doors with rollers on each side with optional rack and pinion that can be secured with a padlock
- Raised and formed bottom to minimize boot contact with concrete
- Head and boot have UHMW seals at shafts
- Head and boot have heavy 1/4" structural frame
- Corrosion-resistant Acme screw take-up
- Bolted construction for easy repair and replacement
- Drip guard/rain guard to shed water and keep internal boot dry
- Optional shovel pocket



Shovel Pocket

Access Door

Optional rack and pinion opener

STANDARD FEATURES

■ Buckets

We use high-density, non-sparking, polyethylene buckets. Nylon, Urethane, and Steel buckets are optional when using highly abrasive materials. Vented buckets are standard.



■ Bearings

Spherical roller bearings are standard on head shaft sizes up to 4 15/16". Split Roller Bearings come standard on 5 7/16" and larger head shaft sizes.

■ Crown-Faced Boot Pulley

This comes standard with any bucket elevator.



■ Slide-Lagging Head Pulley

Replaceable slide-lagging is ideal for the feed and grain industry.



■ Turned, Ground, and Polished Shaft

Sukup utilizes a 1045 TG&P shaft that allows your entire elevator to run smoothly.

■ Low Impact Head Design

The Sukup Bucket Elevator head is a controlled design.

Instead of the product bouncing off the interior of the head, it slides gently along the contour of the hood. Product damage and back-legging are minimized and the need for an internal shroud is eliminated.

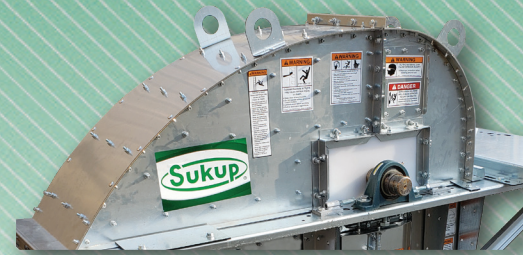

■ Belting

Static conductive, Oil resistant, and Fire Retardant (SOFR) rubber belting is standard on all Sukup Bucket Elevators. Rubber belting has higher bolt retention properties which result in higher maximum bucket projection ratings, and provides maximum oil-based dust suppression additives. Sukup even supplies 10 extra feet of belting with every order to facilitate any belt-splicing configuration you would like to use.



■ Heavy Gauge Trunking

12 or 10 gauge trunking units are standard on all elevators.

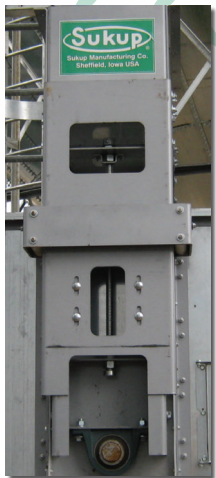

OPTIONAL FEATURES

- **Gravity Take-Up** (pictured on left)
Eases overall use of your bucket elevator. Maintains proper belt tension, and reduces maintenance.

- **Pressure Relief Door**
NFPA compliant pressure relief doors come standard on 36" head section and larger. Optional on all others. This feature is also optional on trunking.

- **Distributor Platform**
Available in 4x8 ft.

- **Standard and Flared Inlet Hoppers** (standard inlet pictured on right)
Optional 10-gauge abrasion-resistant liners. Optional 45° inlets are also available



- **Head Service Platform** (pictured on bottom right)
One of the largest in the industry! Increases safety because there is more room to work. Head platforms come pre-assembled from factory.



■ Winged Boot Pulley

A Winged Pulley is a great option if you are concerned about material collecting on the pulley face.

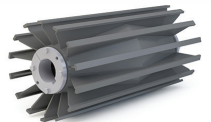

■ Spiral Winged Boot Pulley

Increased pulley-to-belt contact over winged pulley. Eliminates noise caused by winged pulleys.



■ Herringbone Wing Boot Pulley

Wing angles of up to 45°, use the pulleys rotation to eject material out the sides of the pulley.



■ Bearings

Tapered roller bearings are available.

ALSO AVAILABLE...

- Valving
- Reducer Backstops
- Distributors
- Bearing and Surface Sensors
- Guy Brackets
- Belt Misalignment Sensors
- Shovel Pockets
- Ladder & Cage Assembly*
- Motion Sensors
- *Compliant with OSHA standard 1910.28.
- Ceramic Lining

CONVEYORS

STANDARD FEATURES

HY-FLIGHT & DRAG CONVEYORS

■ Removable Bearing, Sprocket and Shaft

The bearing, sprocket and shaft are all one removable unit on Sukup Drag Conveyors for easier maintenance. The entire assembly can be removed without having to separate the shaft from the bearings or the sprocket.



■ Conveyor Covers

Our patented conveyor covers are exclusive to Sukup and will not be found on competitors' products. Our conveyor cover design reduces the number of tools needed for installation and does not require any sealant at the joints. An added bonus...keeps dust in and water out!



Rollers

■ Replaceable Components - Bottoms, Liners, Rails &

Moving a lot of grain? We made it easy to replace the worn out parts without replacing the entire body of the conveyor - an additional feature that can save you both time and money. Consider our standard $\frac{3}{16}$ " and optional $\frac{1}{4}$ " abrasion-resistant bottoms.

■ Pre-Assembled Chains and Paddles

(pictured on right)

Our conveyor chains come pre-assembled with paddles to help speed installation. They are engineered for each specific unit and are either roller bushed or welded steel. Chain pitch will range from 2.609" up to 4.063" with an average ultimate strength of up to 119,000 lbs. UHMW paddles, $\frac{1}{2}$ " thick, eliminate the steel-to-steel contact.



■ Cover Clamp (pictured on right)

Our cover clamps ensure the cover locks tight to the conveyor body.



■ Turned, Ground and Polished Shaft

Sukup utilizes a higher precision 1045 TG&P shaft that allows your entire conveyor to run smoothly. All UHMW shaft seals are $\frac{1}{4}$ " thick.

OPTIONAL FEATURES

HY-FLIGHT & DRAG CONVEYORS

- **Bypass Hoppers & Inlets** - Bypass drive-over hoppers with bar grating are available in 6', 8', and 10' lengths and have an adjustable shroud. Longer lengths are optional. Bypass inlet hoppers are available in 3' and 4' lengths. 2' available in select models.

■ Abrasion-Resistance

10-gauge Abrasion-Resistant liners for sides. $\frac{3}{16}$ " Abrasion-Resistant painted bottoms standard. $\frac{1}{4}$ " Abrasion-Resistant bottoms are also available.

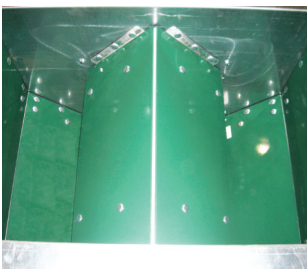

Inlets



Abrasion Resistant Liner

- **End Relief Door** - Prevents damage to the conveyor in the event of a discharge plug.
- **Head Take-Up** - Moves chain tension adjustment from the tail to the head.
- **Intermediate Discharge Gates** - Can act as a separate discharge location in addition to the head anywhere along the trough. Made of 7-gauge construction.
- **Bolted Covers** - Replaces standard clamps with bolts running through top.
- **Split Sprockets** - Hub splits open around shaft for easy maintenance.
- **Shaft Guarding** - Protects users from rotating components.
- **Bolt On Inspection Door**
- **Motion Monitor Sensor**
- **Bearing Temp Sensors**
- **Reversing conveyors available on drags**

HY-FLIGHT CONVEYORS

STANDARD FEATURES

- **Center support plate** at connections prevent return pan from sagging.
- **Heavy-duty bearing mounts** come in 1/4" or 3/8" construction.
- **11-gauge head sides** come standard on 13" and 17" head sections. 7-gauge sides come standard on 21" head sections. All conveyor bodies utilize 11-gauge sides. Conveyor tops are 14-gauge construction. Conveyor bottoms come standard as 3/16" AR construction.
- **Galvanized construction** on all standard conveyors.
- **Open horizontal sections** for grain feed.
- **Modular Curve Section** - If a straight incline just won't fit, adding a curve section might do the trick. The curve sections are available from 10° to 50° inclines in 5° increments. (pictured below)
- Single PC curve section standard on 21" tall and taller
- 1/4" Center Pan standard on 21" and larger

OPTIONAL FEATURES

- **Single Piece Curve Section for 13" and 17"**



Bolted "Tongue"



Modular Curve Section

DRAG CONVEYORS



AR Rail Return

End Relief Door

STANDARD FEATURES

- **Ability to incline** up to 10° on all drags and select models inclines up to 15°. Inclining over 10° will cause a reduction in capacity.
- **11-gauge sides** come standard on 9", 13" and 17" head and tail sections. 7-gauge sides come standard on 21" tall sections. All conveyor bodies utilize 11-gauge sides. Conveyor tops are 14-gauge construction. Conveyor bottoms come standard as 3/16" AR construction.
- **Galvanized construction** on all standard conveyors.
- **Heavy-duty bearing mounts** come in 1/4" or 3/8" construction.

OPTIONAL FEATURES

- **Roller Return** - These UHMW rollers come standard on 9", 12", and 16" wide conveyors.
- **Rail Return** - Comes standard on 21" wide or wider conveyors. Optional on 12"* and 16" wide conveyors. Manufactured with 7-gauge construction with 10-gauge AR wear strip. 3/16" AR strip optional.
- **Chain Slack Detector** - Prevents damage to the conveyor if chain becomes loose or breaks.
- **Reversing Feature** - This feature can take grain in either direction and is a great addition if you are looking to unload into two separate bins.
- **Bend Sections** - 5°, 10°, and 15° sections available.

*may impact fill rate conveyor capacity

TUBE CONVEYORS

DOUBLE RUN CONVEYORS

The **Sukup Double Run Conveyor** causes less grain damage than a portable auger and is more efficient and economical than augers of similar capacity and length. The compact design enables smooth, quiet operation and requires minimum maintenance. Sukup makes the Double Run Conveyor with 100% UHMW paddles, which come pre-attached to the chain. We also offer intermediate discharge gates (horizontal applications only) as an option to further customize your operation.

HEAD SECTION

- ACME threaded take-up comes standard.
- Head discharges available in 45°, 58°, 60°, and 90° angles.
- Optional drive at head.
- Optional overflow door/switch.



INTERMEDIATE DISCHARGE

- Modular design.
- Arrives with tubes attached.
- No cutting required during assembly.
- Grain flows in bottom tube, chain returns in top tube.
- Access door on side for inspection and service.
- Ground control kit optional

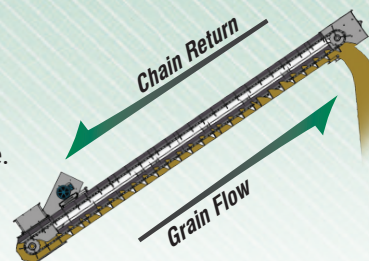

TAIL SECTION

- Standard drive inlet located on tail section. *(pictured on right)*
- Shaft mount Dodge gear reducers *(standard only on 8", 10", and 12" conveyors)*.
- Shaft uses 2 external bearings to take chain load.
- Sukup drive package includes all components - including the motor pulley.
Motor(s) optional.
- Truss Systems optional



minimize GRAIN DAMAGE & **MAXIMIZE** CAPACITY WITH THE **FEED FORWARD TAIL DESIGN**

- Shielded Return Chain allows for better grain quality
- Wider inlet provides better flow and feeding
- Right-hand or left-hand drive possible by flipping over the inlet
- Motor on top or bottom by flipping over the tail tube assembly
- Optional drop through gate to 8", 10" & 12" Double Run



Drop Through Gate



Shielded Return Chain

DID YOU KNOW?

A **DOUBLE RUN CONVEYOR** can replace a roof auger, transfer auger, dryer take-away auger or a permanently installed transport auger.





30°, 32° AND 45° BEND SECTION

Adding a bend section to a Sukup Double Run Conveyor allows you to feed your dryer directly from your hopper bin with one simple, high capacity conveyor. The horizontal section of the conveyor fits under the hopper and is fed using a bypass inlet.

This elbow allows for an incline section creating a more compact conveying system, saving you space in your drying and storing operation.

- Available in 8", 10" or 12"
- 30°, 32°, and 45° Bend Sections
- Head Drive
- Compact, helps utilize space
- Maximizes capacity and grain quality
- Bypass Hopper Inlet available in 2.75'
- Drive Over Hoppers available in 5', 8.5' & 10'

CHAIN LOOP CONVEYORS

With the Sukup Chain Loop Conveyor, you can fill, unload, blend and transfer grain in one complete system. Loop Systems generally require less power and are gentler on the grain than augers. Vertical installation is used when the centers of the bins are in line and the center sumps discharge into the chain loop tube under the floor. Slanted systems will use a separate unload system that will discharge into the lower tube outside of the grain bins. Sukup offers multiple drive-over dump hopper sizes that are designed to work with your Chain Loop Conveyor.



DRIVE CORNER

- 1 or 2 per system based on system requirements.
- 8" system up to 60 HP (2 ea. 30 HP drive corners)
- 10" system up to 100 HP (2 ea. 50 HP drive corners)
- 12" system up to 120 HP (2 ea. 60 HP drive corners)
- Sukup drive package includes all components - including the motor pulley. *Motor(s) optional.*
- Replaceable, abrasion-resistant corners and square to round transitions.
- Dodge shaft mount corner gear reducers use 2 external bearings to take chain load.



STANDARD CORNER

- 1 per system when using 2 drive corners.
- 2 per system when using 1 drive corner.
- Replaceable, abrasion-resistant corners and square to round transitions.

90° DISCHARGE SPOUT

- Gate and control wheel come standard.
- Discharge gates can be operated from the ground using the ground control kit.
- Optional electric gate control.
- Access door on side for inspection and service.



INSPECTION CORNER

- Manual ACME thread take-up comes standard.
- Optional gravity take-up. *(pictured above)*
- Access for inspecting chain and paddle wear, as well as chain tightness.



UHMW paddles are pre-attached to the chain, saving assembly time!

Green UHMW paddles have increased wear resistance



SPECIFICATIONS

BUCKET ELEVATORS

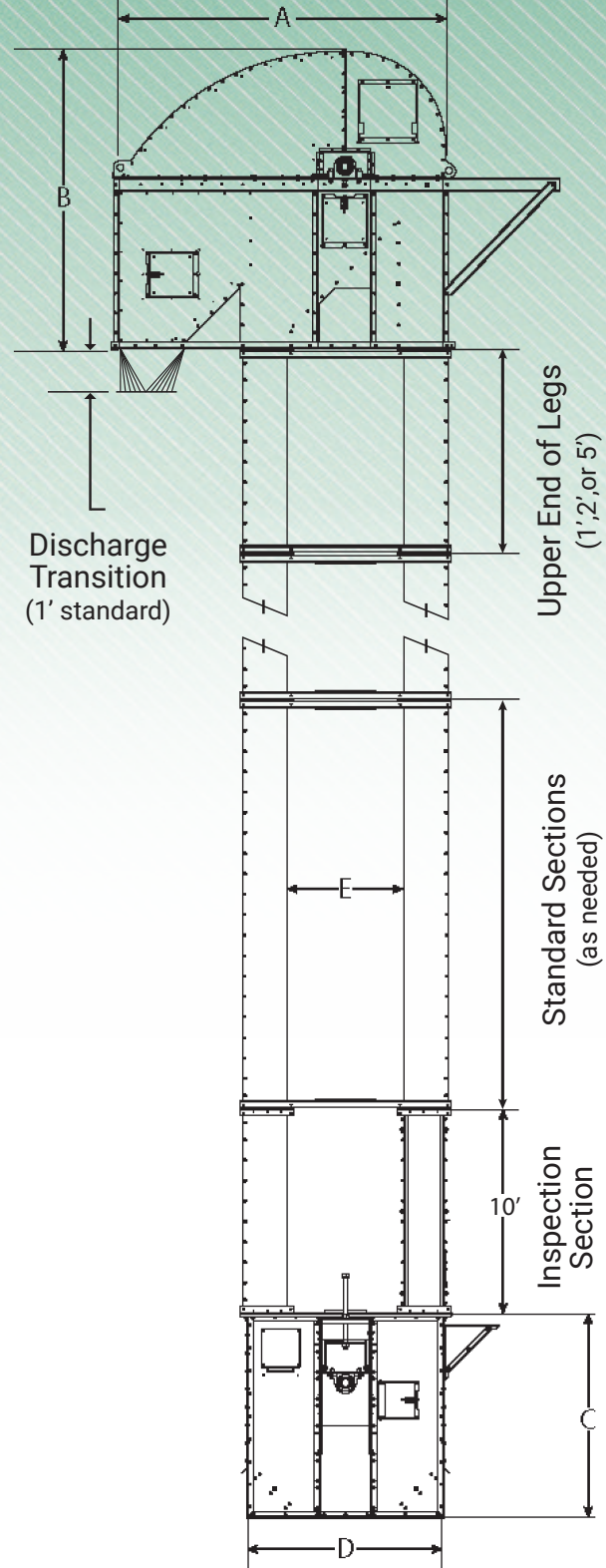

Pulley Diameter	BPH	Bucket		Pulley RPM	Belt Speed (FPM)	Head Shaft*
		Size	Spacing			
16"	1,000	6x5"	9"	83	348	1 15/16"
16"	1,200	6x5"	8"	88	369	1 15/16"
16"	1,400	6x5"	7"	90	377	1 15/16"
16"	1,500	7x5"	7"	85	356	1 15/16"
16"	1,600	7x5"	7"	90	377	1 15/16"
16"	1,800	7x5"	6"	87	364	1 15/16"
16"	2,000	7x5"	6"	97	406	1 15/16"
24"	1,500	9x5"	9"	58	364	2 3/16"
24"	2,000	9x5"	8"	69	434	2 3/16"
24"	2,500	9x6"	9 1/2"	69	434	2 7/16"
24"	3,000	9x6"	8 1/4"	73	459	2 7/16"
24"	3,500	9x6"	7"	71	446	2 7/16"
24"	4,000	9x6" LP**	6"	73	459	2 7/16"
24"	4,500	9x6" LP**	5"	69	434	2 7/16"
24"	5,000	9x6" LP**	5"	77	484	2 7/16"
30"	4,000	12x6"	9"	63	495	2 7/16"
30"	4,500	12x7"	10 1/4"	60	471	2 7/16"
30"	5,000	12x7"	9 1/4"	60	471	2 7/16"
30"	5,500	13x7"	9"	60	471	2 7/16"
30"	6,000	13x7"	9"	65	511	2 7/16"
30"	6,500	13x7"	8"	63	495	2 7/16"
30"	7,000	13x7"	8"	68	534	2 7/16"
30"	7,500	14x7"	8"	69	542	2 7/16"
36"	6,000	13x7"	9 1/2"	57	537	2 7/16"
36"	6,500	13x7"	9 1/2"	57	537	2 7/16"
36"	7,000	13x7"	8 3/4"	62	584	2 7/16"
36"	7,500	13x7"	8 1/2"	64	603	2 7/16"
36"	8,000	13x7"	8"	64	603	2 7/16"
36"	8,500	14x7"	8"	65	613	2 7/16"
36"	9,000	13x7" LP**	6 1/2"	62	584	2 7/16"
36"	10,000	13x7" LP**	6"	64	603	2 7/16"
42"	8,000	14x7"	9"	59	649	3 7/16"
42"	8,500	14x7"	8 1/2"	59	649	3 7/16"
42"	9,000	14x7"	8"	59	649	3 7/16"
42"	10,000	16x7"	8"	58	638	3 7/16"
42"	11,000	16x7" LP**	7"	57	627	3 7/16"
42"	12,000	16x8"	9 3/4"	57	627	3 7/16"
42"	13,000	16x8"	9"	57	627	3 7/16"
42"	14,000	16x8"	9"	61	671	3 7/16"
42"	15,000	18x8"	9 1/4"	59	649	3 7/16"
42"	16,000	18x8" LP**	8"	57	627	3 7/16"
42"	17,000	18x8" LP**	7 1/2"	57	627	3 7/16"
48"	15,000	18x8"	10 1/4"	57	716	3 7/16"
48"	16,000	18x8"	9 1/2"	56	704	3 7/16"
48"	17,000	18x8"	9"	56	704	3 7/16"
48"	18,000	18x8" LP**	8 1/2"	56	704	3 7/16"
48"	19,000	18x8" LP**	8"	56	704	3 7/16"
48"	20,000	18x8" LP**	7 1/2"	56	704	3 7/16"

* Value dependent upon height ** Low Profile **NOTE:** Other configurations available.

Pulley Diameter	BPH	Head Gauge	Hood Gauge	Boot Shaft*	Boot Gauge	Trunking Gauge	Trunking Size	Nominal Dimensions				
								A	B	C	D	E
16"	All	12ga	14ga	1 15/16"	10ga	12ga	11x8"	51"	50"	60"	30"	14"
24"	All	12ga	14ga	1 15/16"	10ga	12ga	13x10"	66"	60"	60"	43"	23"
30"	All	8ga	12ga	2 7/16"	10ga	12ga	18x12"	83"	75"	60"	52"	28"
36"	All	8ga	12ga	2 7/16"	10ga	12ga	18x12"	96"	88"	60"	58"	34"
42"	All	8ga	12ga	2 15/16"	7ga	12ga	22x14"	108"	101"	72"	68"	40"

DISTRIBUTORS

- 45° wing-back design; heavy-duty, galvanized compact construction; dust and weather tight to reduce contamination.
 - Dense, bristle brush seal to minimize product build up inside the distributor and leakage of product into adjacent bins.
 - Top and bottom bearing for smooth, easy operation
 - Positive locking system for precise spout positioning
 - Discharge stubs manufactured from 10 gauge abrasion resistant steel
 - Hinged door for inspection and maintenance
 - Standard cable control kit
 - Internal spout bolted for easy parts replacement
- Optional lined with ¼" EMB urethane

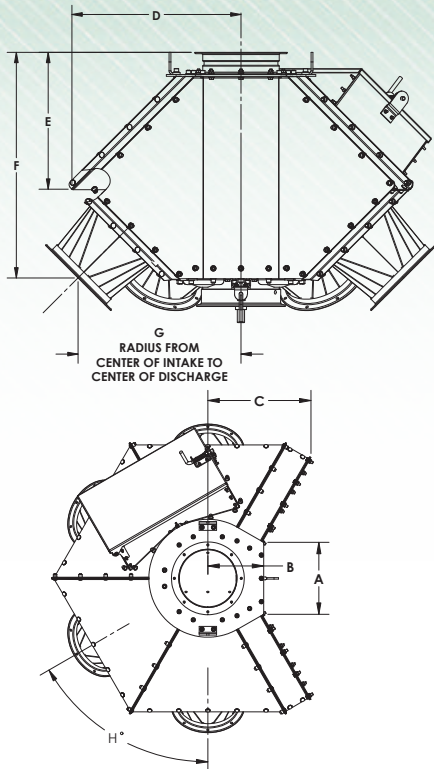

SIZE	SUKUP DISTRIBUTOR							
	A	B	C	D	E	F	G	H
8"- 4 Duct	12 3/8"	9 19/32"	17 5/8"	22 15/16"	18 9/16"	30 19/32"	22 3/32"	60°
8"- 6 Duct	10 3/8"	9 19/32"	17 5/8"	24 15/16"	20 31/32"	32 9/32"	24 7/16"	40°
8"- 8 Duct	10"	9 19/32"	19 29/32"	30 5/32"	25 7/8"	37 9/16"	29 21/32"	30°
10"- 4 Duct	12 3/8"	9 19/32"	17 5/8"	22 15/16"	18 9/16"	30 19/32"	22 3/32"	60°
10"- 6 Duct	12 3/8"	9 19/32"	20 1/16"	29 1/2"	24 1/2"	36 17/32"	28 5/8"	40°
10"- 8 Duct	11 9/16"	9 19/32"	22 19/32"	34 3/4"	30 3/16"	42 7/32"	33 29/32"	30°
12"- 4 Duct	14 3/8"	11 1/32"	21 17/32"	27 15/16"	21 15/16"	35 7/32"	26 1/16"	60°
12"- 6 Duct	12 5/16"	12 3/32"	23 27/32"	33 27/32"	28 3/32"	41 11/32"	32 1/8"	40°
12"- 8 Duct	14 3/8"	11 1/32"	25 15/32"	39"	35 3/8"	47 9/16"	38 11/32"	30°

NOTE: Other sizes are available through an outside source. Please contact Sukup Manufacturing Co. for further information.

CHAIN LOOP CONVEYORS

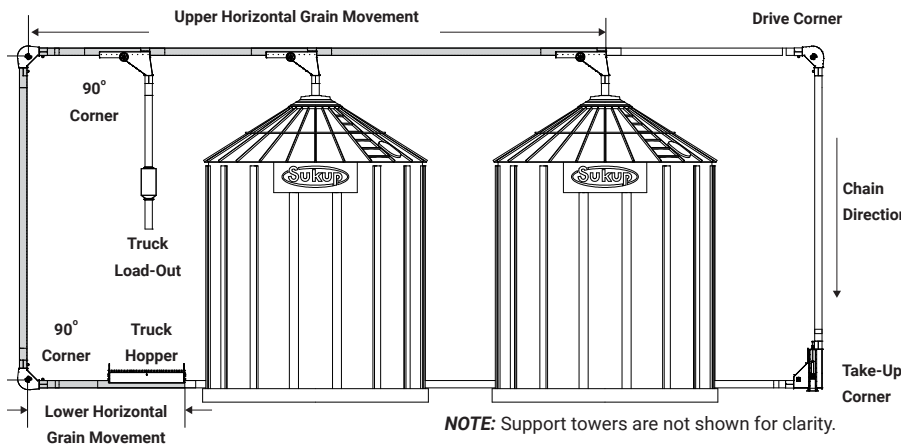

	8"	10"	12"
Maximum Capacity (BPH)	4000	6000	10,000
Chain Travel (FPM)	325	325	400
Tubing Gauge - (Galvanized)	10	10	7
Corner Housing Thickness - (Galvanized)	3/16"	3/16"	3/16"
Paddle Thickness (UHMW)	3/8"	1/2"	1/2"
Head Shaft RPM	94	94	83
Corner Shaft Diameter	2"	3"	3 7/16"
Conveyor Chain Standard	81XHH	81XHH	81XHH
Vertical HP (per foot of conveyance)	.35	.50	.75
Horizontal HP (per foot of conveyance)	.08	.11	.18
Empty Weight (without grain)	18 lb./ft.	22 lb./ft.	33 lb./ft.
Full Weight (56 lb./bu. material)	34 lb./ft.	47lb./ft.	68 lb./ft.

SPECIFICATIONS

DOUBLE RUN CONVEYORS

	Maximum Conveyor Lengths (Feet)					
	Electric HP	Degree of Incline				
		Horiz.	15°	30°	45°	60°
12"	15	83	55	37	28	23
	20	111	74	50	38	31
	30	166	112	75	57	47
	40	222	149	100	76	63
	60	333	223	151	114	95
10"	10	88	59	40	30	25
	15	132	88	60	45	37
	20	175	118	80	60	49
	25	219	147	100	75	62
	30	263	176	120	90	74
8"	5	66	44	30	23	19
	10	132	88	60	45	37
	15	197	133	90	68	56
	20	263	177	120	90	74
6"	3	71	48	35	25	21
	5	119	80	58	41	35
	7.5	178	120	88	62	53
	10	238	161	117	83	71

Dimensions of Conveying Chamber	6" Round (20.3 cm)	8" Round (20.3 cm)	10" Round (25.4 cm)	12" Round (30.5 cm)
*Maximum Capacity	*1500 BPH (41 MTPH)	*4000 BPH (108 MTPH)	*6000 BPH (162 MTPH)	*10,000 BPH (270 MTPH)
Chain Travel	338 FPM (1.71 MPS)	329 FPM (1.67 MPS)	348 FPM (1.77 MPS)	400 FPM (2.03 MPS)
Head Shaft RPM	126	126	114	102
Housing Gauge Galv.	14 (1.9 mm)	10 (2.66 mm)	10 (2.66 mm)	7 (3.433 mm)
Paddles UHMW	3/8" (10 mm)	3/8" (10 mm)	1/2" (13 mm)	1/2" (13 mm)
Conveyor Chain	81 X	81 X	81 XHH	81 XHH
Conveyor Sprocket	12 Tooth	12 Tooth	14 Tooth	18 Tooth
Weight/Foot (lbs)				
Empty	30	39	53	78
Plugged	55	69	101	147
Max Span (without Truss)	32'	44'	48'	55'

NOTE: Maximum capacity is also figured in metric tons per hour (MTPH).

*Capacity based on 0° incline. Increasing incline will result in capacity reduction.

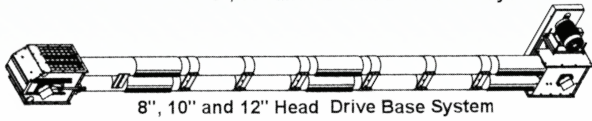
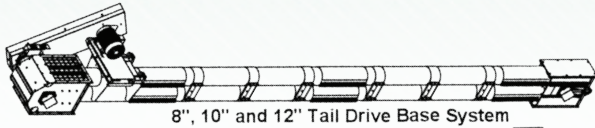

Angle of Operation	Decrease in Capacity	CAPACITIES BPH			
		6"	8"	10"	12"
0°	0%	1,500	4,000	6,000	10,000
15°	15%	1,275	3,400	5,100	8,500
30°	25%	1,125	3,000	4,500	7,500
45°	45%	825	2,200	3,300	5,500
60°	60%	660	1,600	2,400	4,000

*Based on clean, dry corn with complete fill of inlet.

32° and 45° BEND SECTION

Size / Elbow Degree	A	B	C	D	E	F	G	H
8" / 32° Elbow	44 1/16"	*	40 15/16"	67"	42 11/16"	19 5/8"	13 3/8"	60 15/16"
8" / 45° Elbow	44 1/16"	*	47 1/8"	59 1/16"	42 11/16"	19 5/8"	31 5/16"	77 3/16"
10" / 32° Elbow	46 1/16"	*	44 1/2"	70 13/16"	44 11/16"	24 1/2"	15 9/16"	68"
10" / 45° Elbow	46 1/16"	*	52 5/16"	63 1/8"	44 11/16"	24 1/2"	35 9/16"	85 11/16"
12" / 32° Elbow	53 1/8"	*	54 3/8"	84 3/16"	51 11/16"	29 9/16"	21 1/16"	81 1/4"
12" / 45° Elbow	53 1/8"	*	65 3/4"	76 9/16"	51 11/16"	29 9/16"	46 3/8"	103 7/8"

*Determined by hopper tube length.

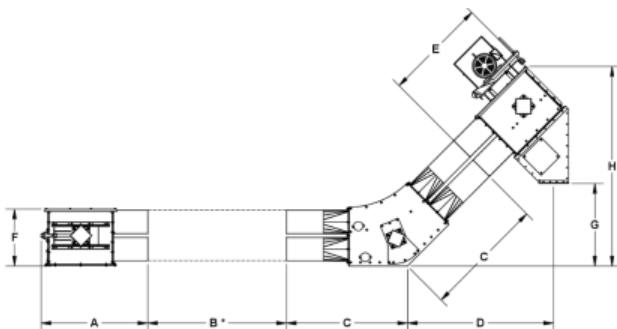

Using HP chart for straight Double Runs (above section, right chart), calculate horizontal horsepower based on design length and add to inclined horsepower based on design length and incline angle. Round total up to the next size drive package.

i.e. Overall length of horizontal section x HP factor + overall length of 45° section x HP factor = required HP. Round up to next size drive package.

Example: 8", 45° conveyor. Horizontal section is 30'. Inclined section is 40'.

i.e. 30' x .076 = 2.28HP

40' x .222 = 8.88HP

2.28HP + 8.88HP = 11.16HP.

Round up to a 15HP system & reducer.



DRAG CONVEYORS

Model #	CAPACITIES BPH				Inside Width A	Inside Height B	Overall Width C	Head Height D	Discharge Opening J	Tail Length Q	Head Length P	Min. Inlet Distance H**	Inlet Length K*	Min. Length L**	Min. Length M**
	100 FPM	125 FPM	150 FPM	180 FPM											
909	1352	1691	2029	2434	9 1/2"	9"	12"	15"	26"	37 1/2"	61 1/2"	33"	24"	45"	14 1/2"
913	2374	2968	3562	4274	9 1/2"	13"	12"	15"	26"	37 1/2"	61 1/2"	41"	24"	53"	14 1/2"
1209	1903	2379	2854	3425	12 1/2"	9"	15 1/2"	15"	26"	37 1/2"	61 1/2"	33"	24"	45"	14 1/2"
1213	3334	4168	5002	6002	12 1/2"	13"	15 1/2"	15"	26"	37 1/2"	61 1/2"	41"	24"	53"	14 1/2"
1217	4829	6036	7244	8693	12 1/2"	17"	15 1/2"	19"	26"	37 1/2"	61 1/2"	50"	24"	62"	14 1/2"
1609	2525	3156	3787	4545	16 1/2"	9"	19 1/2"	15"	26"	37 1/2"	61 1/2"	33"	24"	45"	14 1/2"
1613	4425	5531	6637	7965	16 1/2"	13"	19 1/2"	15"	26"	37 1/2"	61 1/2"	41"	24"	53"	14 1/2"
1617	6408	8010	9612	11,535	16 1/2"	17"	19 1/2"	19"	26"	37 1/2"	61 1/2"	50"	24"	62"	14 1/2"
1621	8472	10,590	12,708	15,249	16 1/2"	21"	19 1/2"	23"	36"	43"	71 1/2"	68"	24"	80"	19 1/2"
2109	3225	4031	4837	5805	21"	9"	24"	15"	26"	37 1/2"	61 1/2"	33"	24"	45"	14 1/2"
2113	5651	7064	8477	10,173	21"	13"	24"	15"	26"	37 1/2"	61 1/2"	41"	24"	53"	14 1/2"
2117	8185	10,231	12,277	14,733	21"	17"	24"	19"	26"	37 1/2"	61 1/2"	50"	24"	62"	14 1/2"
2121	10,820	13,526	16,231	19,477	21"	21"	24"	23"	36"	43"	71 1/2"	68"	24"	80"	19 1/2"
2721	13,953	17,441	20,930	25,116	27"	21"	30"	23"	36"	43"	71 1/2"	67 1/2"	27"	81"	19 1/2"
3321	17,086	21,357	25,628	30,754	33"	21"	36"	23"	36"	43"	71 1/2"	68"	30"	83"	19 1/2"

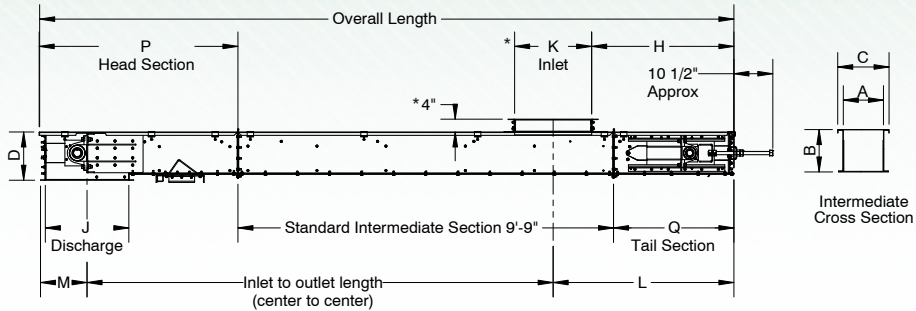

* Contact Sukup Manufacturing Co. for dimensional information on other styles of inlets.

** Estimates only. Contact Sukup Manufacturing Co. for actual dimensions.

NOTE: Capacities based on clean, dry, whole grains; All 9" conveyors have tapered head sections.

DRAG CONVEYOR WITH BEND AND INCLINE SECTIONS

- Bend and incline sections are used to increase discharge height.
- 5° bend and incline sections give you 1 1/32" of rise for every foot of run.
- 10° bend and incline sections give you 2 1/8" of rise for every foot of run.

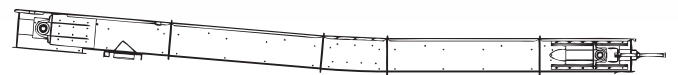

NOTE: use of 10° bend and incline sections requires a double paddle chain.

HY-FLIGHT CONVEYORS

NOTE: The use of a by-pass inlet will decrease the conveyor capacity.

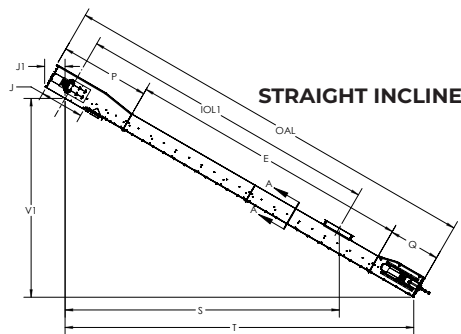

Model #	CAPACITIES BPH				A	B	B1	B2	C	P	Q	TU	RAD
	100 FPM	125 FPM	150 FPM	175 FPM									
HF1213	2,064	2,580	3,097	3,613	12 1/2"	14 1/2"	6 1/4"	8 1/8"	15 1/2"	73 1/2"	42 1/4"	10 1/2"	68
HF1613	2,740	3,425	4,110	4,796	16 1/2"	14 1/2"	6 1/4"	8 1/8"	19 1/2"	73 1/2"	42 1/4"	10 1/2"	68
HF1617	3,617	4,521	5,426	6,330	16 1/2"	18 1/2"	8 1/4"	10 1/8"	19 1/2"	73 1/2"	42 1/4"	10 1/2"	68
HF2117	4,621	5,776	6,931	8,087	21"	18 1/2"	8 1/4"	10 1/8"	24"	73 1/2"	42 1/4"	10 1/2"	68
HF2121	5,741	7,176	8,612	10,047	21"	22 1/2"	10 1/4"	12 1/8"	24"	73 1/2"	42 1/4"	10 1/2"	68
HF2721	7,404	9,255	11,106	12,957	27"	22 1/2"	10 1/4"	12 1/8"	30"	73 1/2"	42 1/4"	10 1/2"	84
HF3321	9,067	11,333	13,600	15,867	33"	22 1/2"	10 1/4"	12 1/8"	36"	73 1/2"	42 1/4"	10 1/2"	84

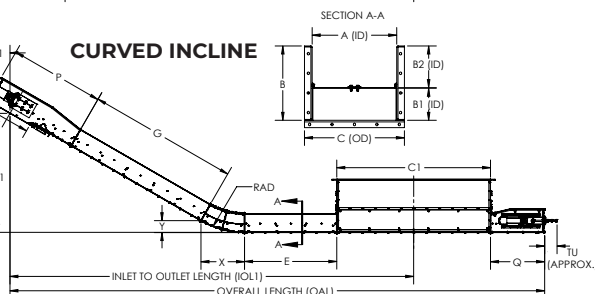

	J1			X			Y		
	HF1213-HF1617	HF2117-HF3325	HF3330	HF1213-HF2121	HF2721-HF3325	HF3330	HF1213-HF2121	HF2721-HF3325	HF3330
10°	16 1/4"	19 3/16"	20 3/16"	11 13/16"	14 9/16"	14 5/8"	1"	1 1/4"	1 5/16"
15°	15 15/16"	18 7/8"	19 3/16"	17 9/16"	21 3/4"	21 3/4"	2 5/16"	2 7/8"	2 7/8"
20°	15 1/2"	18 5/16"	19 1/4"	23 1/4"	28 3/4"	29"	4 1/8"	5 1/16"	5 3/16"
25°	14 15/16"	17 11/16"	18 9/16"	28 3/4"	35 1/2"	36 11/16"	6 3/8"	7 7/8"	8"
30°	14 9/16"	16 7/8"	17 3/4"	34"	42"	42 7/16"	9 1/8"	11 1/4"	11 7/16"
35°	13 1/2"	16"	16 3/16"	39"	48 3/16"	48 11/16"	12 5/16"	15 3/16"	15 7/17"
40°	12 5/8"	14 15/16"	15 1/16"	43 3/4"	54"	54 5/8"	15 15/16"	19 5/8"	20"
45°	11 11/16"	13 13/16"	14 1/2"	48 1/16"	59 3/8"	60 1/8"	19 15/16"	24 5/8"	25 1/16"

SPECIFICATIONS HOPPERS & INLETS

BY-PASS HOPPER WITH DRIVE OVER GRATING

Model #	By-Pass Hopper with Drive-Over Grating		
	A	B	C
HF1213	55 3/4"	47 1/2"	42 7/16"
HF1613	55 3/4"	47 1/2"	42 7/16"
HF1617	55 3/4"	47 1/2"	42 7/16"
HF2117	55 3/4"	47 1/2"	42 7/16"
HF2121	55 3/4"	47 1/2"	42 7/16"
HF2721	55 3/4"	47 1/2"	42 7/16"
HF3321	67 3/4"	59 1/2"	54 1/2"

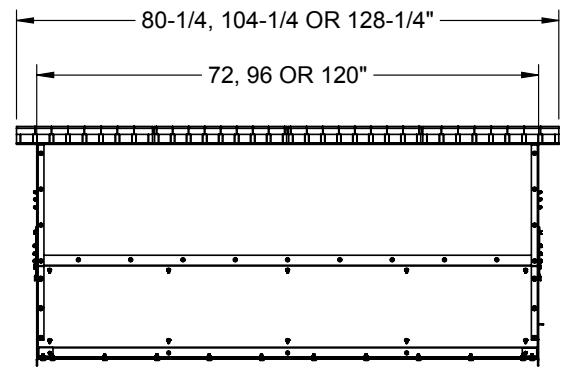
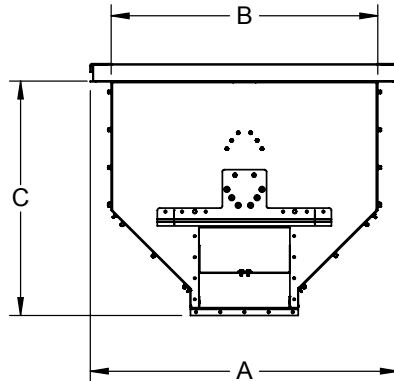

BY-PASS INLET

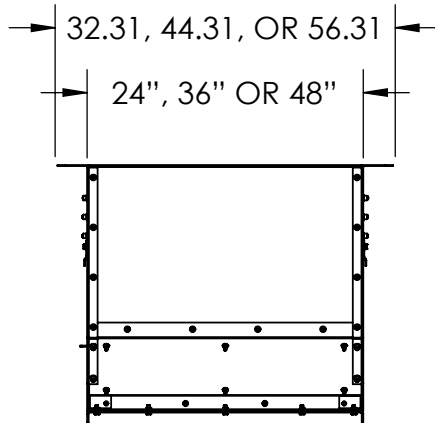
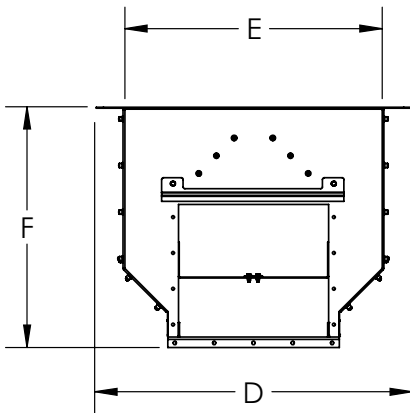

Model #	By-Pass Inlet		
	D	E	F
HF1213	44 1/2"	35 3/4"	27 1/2"
HF1613	44 1/2"	35 3/4"	27 1/2"
HF1617	44 1/2"	35 3/4"	33 1/2"
HF2117	44 1/2"	35 3/4"	33 1/2"
HF2121	44 1/2"	35 3/4"	37 1/2"
HF2721	44 1/2"	35 3/4"	41 1/2"
HF3321	56 1/2"	47 3/4"	44 1/2"

2' and 3' sections not available in all sizes.

NOTE: Available in longer overall lengths using multiple hoppers that bolt to each other.

Contact Sukup Manufacturing Co. for further information.

WIDE BY-PASS HOPPER

Model #	Low Profile ByPass Hopper						
	A	B	C	D	E	F	G
HF1213	61"	53 1/8"	24 1/16"	5 1/16"	15 1/2"	12 1/2"	14 1/2"
HF1613	69"	61"	26 1/16"	5 1/16"	19 1/2"	16 1/2"	14 1/2"
HF1617	77 5/8"	70"	30 5/16"	5 1/16"	19 1/2"	16 1/2"	18 1/2"
HF2117	86 11/16"	78 5/16"	32 1/2"	5 1/16"	24"	21"	18 1/2"
HF2121	94 1/2"	86 5/16"	36 7/16"	5 1/16"	24"	21"	22 1/2"
HF2721	106 5/8"	98 9/16"	39 9/16"	5 1/16"	30"	27"	22 1/2"
HF3321	Contact Sukup Manufacturing			36"	33"	22 1/2"	

NOTE: For commercial applications see Material Handling Commercial Series brochure

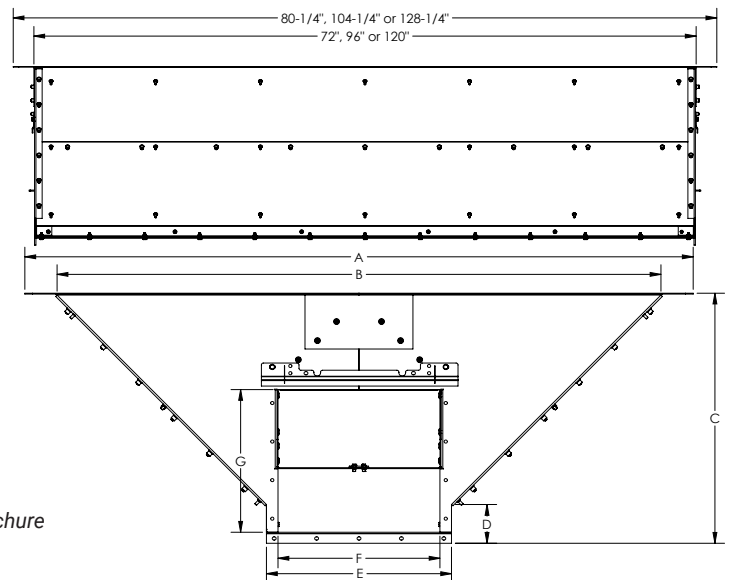

Sukup Manufacturing Co. ■ www.sukup.com

Box 677 ■ 1555 255th Street ■ Sheffield, Iowa 50475-0677 ■ ph 641.892.4222 ■ fx 641.892.4629 ■ info@sukup.com

Distribution Centers

Cameron, MO 64429
7426 NE 352nd St.
ph 816.649.2226
missouri@sukup.com

Arcola, IL 61910
980 E. State Rte. 133
ph 217.268.3026
illinois@sukup.com

York, NE 68467
2311 N Division Ave.
ph 402.694.5922
nebraska@sukup.com

Defiance, OH 43512
7724 Rte. 66 N.
ph 419.784.9871
ohio@sukup.com

Jonesboro, AR 72403
204 Best Industrial Dr.
ph 870.932.7547
arkansas@sukup.com

Watertown, SD 57201
2701 Piper Ave.
ph 605.882.6697
southdakota@sukup.com